

Economic Community of West African States, African Regional Bodies

Supplementary Act/SP.1/08/11 Relating to the Harmonization of Standards and Procedures for the Control of Dimensions, Weight and Axle Load of Goods Vehicle within Member States of the Economic Community of West African States

Act 8-1 of 2011

Legislation as at 19 July 2011

FRBR URI: /akn/aa-ecowas/act/2011/8-1/eng@2011-07-19

There may have been updates since this file was created.

PDF created on 23 August 2023 at 15:25.

[Check for updates](#)



About this collection

The legislation in this collection has been reproduced as it was originally printed in the Government Gazette, with improved formatting and with minor typographical errors corrected. All amendments have been applied directly to the text and annotated. A scan of the original gazette of each piece of legislation (including amendments) is available for reference.

This is a free download from the Laws.Africa Legislation Commons, a collection of African legislation that is digitised by Laws.Africa and made available for free.

www.laws.africa
info@laws.africa

There is no copyright on the legislative content of this document.

This PDF copy is licensed under a Creative Commons Attribution 4.0 License (CC BY 4.0). Share widely and freely.

Supplementary Act/SP.1/08/11 Relating to the Harmonization of Standards and Procedures for the Control of Dimensions, Weight and Axle Load of Goods Vehicle within Member States of the Economic Community of West African States

Contents

- Chapter I – Definitions, objective and scope of application 2
 - Article 1 – Definitions 2
 - Article 2 – Objective and scope of application 2
 - Paragraph 1. 2
 - Paragraph 2. 2
 - Paragraph 3. 2
- Chapter II – Limits to the dimensions, weight and axle load of heavy duty goods transport vehicles 2
 - Article 3 – Limits to heavy duty vehicle dimensions 2
 - Article 4 – Limits of axle load 2
 - Article 5 – Limits to laden weight 2
 - Article 6 – Exceptions for exceptional transport 2
- Chapter III – Measures to implement and control the standards 3
 - Article 7 – Load and dimensions inspection certificate 3
 - Paragraph 1. 3
 - Paragraph 2. 3
 - Article 8 – Technical inspection of heavy-duty vehicles 3
 - Paragraph 1. 3
 - Subparagraph a) 3
 - Subparagraph i) 3
 - Subparagraph ii) 3
 - Subparagraph iii) 3
 - Subparagraph b) 3
 - Paragraph 2. 3
 - Paragraph 3. 3
 - Paragraph 4. 3
 - Paragraph 5. 3
 - Article 9 – Obligatory inspection of equipment and devices 3
 - Paragraph A. – For Member States 3
 - Subparagraph 1) 3
 - Subparagraph 2) 3
 - Subparagraph 3) 4
 - Subparagraph 4) 4

Paragraph B. – For platforms that generate heavy traffic	4
Subparagraph 1)	4
Subparagraph 2)	4
Subparagraph 3)	4
Chapter IV – Inspection of heavy-duty vehicles dimension, weight and axle load along road corridors	4
Article 10 – Responsibilities of loading platforms prior to departure of a laden truck	4
Paragraph 1.	4
Paragraph 2.	4
Paragraph 3.	4
Paragraph 4.	4
Article 11 – Responsibilities of vehicle operators prior to departure of laden trucks	4
Article 12 – Inspection at fixed posts	5
Paragraph 1.	5
Paragraph 2.	5
Paragraph 3.	5
Article 13 – Inspection by mobile brigade	5
Paragraph 1.	5
Paragraph 2.	5
Paragraph 3.	5
Paragraph 4.	5
Paragraph 5.	5
Article 14 – Content of road inspection and mode of management	5
Paragraph 1.	5
Paragraph 2.	5
Paragraph 3.	5
Chapter V – Sanctions for non-compliance with the dimensions, weight and axle load limits	6
Article 15 – Content of the sanctions	6
Paragraph 1.	6
Paragraph 2.	6
Subparagraph a)	6
Subparagraph b)	6
Paragraph 3.	6
Article 16 – Compulsory overload shedding and correction of dimensions	6
Paragraph 1.	6
Paragraph 2.	6

Paragraph 3.	6
Paragraph 4.	6
Paragraph 5.	6
Article 17 – Immobilization of vehicle and compulsory cargo trans-shipment	6
Paragraph 1.	6
Paragraph 2.	6
Paragraph 3.	7
Article 18 – Fine	7
Paragraph 1.	7
Paragraph 2. – In the absence of dimension and tare plates	7
Paragraph 3. – For lack of inspection certificate	7
Subparagraph 1.	7
Subparagraph 2.	7
Paragraph 4. – For breach of dimension standards	7
Subparagraph 1.	7
Subparagraph 2.	7
Paragraph 5. – For exceeding the total travelling weight of the vehicle	7
Paragraph 6. – For axle overload	7
Subparagraph 1	7
Subparagraph 2.	7
Article 19 – Special case of transportation of hydrocarbons, explosives and certain dangerous cargo	7
Paragraph 1.	7
Paragraph 2.	8
Paragraph 3.	8
Article 20 – Increased fine for repeated breach	8
Paragraph 1.	8
Paragraph 2.	8
Paragraph 3.	8
Article 21 – Fines for proven offences at inspection fixed posts	8
Article 22 – Obligation to implement sanctions	8
Article 23 – Fine imposed for deliberate refusal to pass through the weigh-bridge and axle weighing scales	8
Article 24 – Sanction against platforms and facilities generating out-going road traffic of over 200,000 tones	8
Paragraph 1.	8
Paragraph 2.	8

Chapter VI – General and final provisions	9
Article 25 – Adaption and/or amendment of technical standards of vehicles and sanctions	9
Paragraph 1.	9
Paragraph 2.	9
Article 26 – Other obligations	9
Paragraph 1.	9
Paragraph 2.	9
Paragraph 3.	9
Article 27 – Transition period	9
Paragraph 1.	9
Subparagraph i.	9
Subparagraph ii.	9
Paragraph 2.	9
Paragraph 3.	9
Article 28 – Moratorium	9
Paragraph 1.	9
Paragraph 2.	10
Paragraph 3.	10
Article 29 – Publication	10
Article 30 – Entry into force	10
Article 31 – Miscellaneous provisions	10
Article 32 – Depository authority	10
Annex 1	11
Annex 2	16

Economic Community of West African States

Supplementary Act/SP.1/08/11 Relating to the Harmonization of Standards and Procedures for the Control of Dimensions, Weight and Axle Load of Goods Vehicle within Member States of the Economic Community of West African States

Act 8-1 of 2011

Published in official journal 59 on 1 August 2011

Commenced in full on 1 August 2011

[This is the version of this document as it was at 19 July 2011 to 31 July 2011.]

MINDFUL of Articles 7, 8 and 9 of the ECOWAS Treaty as amended, establishing the Authority of Heads of State and Government and defining its composition and functions;

MINDFUL of Article 32 of the said Treaty which provides for the adoption of common transport and communication policies laws and Regulations as a means of ensuring harmonious integration of the physical infrastructure of Member States and the promotion and facilitation of movement of persons, goods and services within the Community;

MINDFUL of Decision A/DEC. 2/5/81 relating to the harmonization of highway legislations in the Community;

MINDFUL of the ECOWAS Convention No. A/P2/5/82 of 29 May 1982 Relating to Inter-State Road Transportation between ECOWAS Member States providing amongst other issues, the tonnage for axle load and other dimensions for vehicles;

MINDFUL of Resolution C/RES.5/5/90 of 27 May 1990 urging Member States to introduce Weighbridge and axle scales as a means of effectively monitoring the tonnage transported as well as axle load;

MINDFUL of Decision C/DEC.7/7/91 of 3 July 1991 Relating to the Road Traffic Regulations based on 11.5 Axle Load to protect Road Infrastructures and Road Transport Vehicles, especially the annex thereof, which provides for eventual harmonization of the sanctions imposed on any one in breach of the said Regulations;

MINDFUL of Decision A/DEC. 2/8/94 relating to the Community Programme on Road Safety and Accident prevention in ECOWAS Member States;

MINDFUL of Decision A/DEC.6/7/96 of 27th July 1996 establishing standards for the design of Community roads;

CONSIDERING [Regulation 14/2005/CM/UEMOA](#) of 16 December 2005 on Harmonization of the Control of Dimension, Weight and Axle Load of Heavy Duty Goods Transport Vehicles in UEMOA Member States;

CONSIDERING Resolution No. 2 of the Meeting of ECOWAS Transport Ministers on Implementation of the Regulation on the Control of Vehicle Axle Load, held in Yamoussoukro in Côte d'Ivoire on 5 June 2009;

CONSIDERING the March 2010 road map forbidding transport overloading adopted by the UEMOA Ministers in Charge of Infrastructure and Transport in Ghana.

DETERMINED to effectively preserve the road heritage of Member States;

DESIROUS of the harmonization of standards, and procedures for the control of load, dimension limits, and axle load of vehicles amongst Member States of the Community;

ON THE RECOMMENDATION of meeting of Ministers of Road Transport and Infrastructure for the Review and adoption of the ECOWAS Axle Load and the PPDU Regulations which was held in Accra on 1st April 2011;

HAVING OBTAINED the opinion of the Community Parliament;

HAVE AGREED AS FOLLOWS:

Chapter I

Definitions, objective and scope of application

Article 1 – Definitions

The technical terms used in this Supplementary Act with regard to vehicle type, vehicle axle, vehicle dimensions and weight and to goods transport activity, are defined in Annex 1 attached to this Supplementary Act.

Article 2 – Objective and scope of application

1. The objective of this Supplementary Act is to harmonize amongst ECOWAS Member States, the standards the control of dimension, weight and axle load of heavy duty goods transport vehicles, and the sanctions imposed for non-compliance with these standards.
2. This Supplementary Act complements and amends all relevant ECOWAS texts, particularly Convention A/P2/5/82 of 29 May 1982, Decision C/DEC/7/7/9 of 13 July 1991 and Council of Ministers Resolution 5/5/90 of 27 May 1990.
3. Annexes 1 and, 2 to this Supplementary Act form an integral part thereof. The weight and dimension limits set forth herein, deriving from the aforementioned previous texts, shall constitute the load standards for heavy-duty goods transport vehicles plying public roads in ECOWAS Member States.

Chapter II

Limits to the dimensions, weight and axle load of heavy duty goods transport vehicles

Article 3 – Limits to heavy duty vehicle dimensions

The external dimensions of any vehicle or assembly of vehicles plying the road network of ECOWAS Member States shall not exceed the authorized maximum dimensions set forth in Annex 2 of this Supplementary Act.

Article 4 – Limits of axle load

In accordance with Article 4 of Convention A/P2/5/82 of the Authority of Heads of State and Government of ECOWAS and Article 1 of the Council of Ministers Decision C/DEC/7/7/91, transport vehicle traffic on roads networks of ECOWAS Member States shall be permissible subject to a maximum axle load of 11.5 tons for single load-carrying axles.

The Authorized Maximum Axle Loads (AMAL) for the various types of axle are listed in Annex 2 of this Supplementary Act.

Article 5 – Limits to laden weight

For each type of vehicle or assembly of vehicles, the authorized Total Laden Weight (ATLW) or the authorized Total Transported Weight (ATTW) shall be defined in conformity with Annex 2 of this Regulation.

Article 6 – Exceptions for exceptional transport

In conformity with Article 7 of the Convention A/P2/5/82 and as provided in the annex to Decision 7/7/91 Special transport vehicles or exceptional convoys of vehicles that are not compliant with the standards defined in Article 3, 4 and 5 of this Supplementary Act shall, while transiting in each Member State, be subject to

prior authorization for exceptional transport issued by the competent authorities. The beneficiary of such authorization shall hold the same in possession in the course of the journey.

Chapter III

Measures to implement and control the standards

Article 7 – Load and dimensions inspection certificate

1. Pursuant to implementation of this Supplementary Act, each Member State shall formulate and incorporate in its official transport document (traffic document or road consignment note) a note in the certificate attesting that a vehicle's weight and dimensions have been duly checked. The total laden weight and the overall axle system load of the concerned vehicle shall be clearly mentioned, and there shall be express indication as to the vehicle's conformity with the dimension standards.
2. With respect to exceptional transport, the authorization for exceptional transport set forth in Article 6 shall apply.

Article 8 – Technical inspection of heavy-duty vehicles

1. Prior to registration and entry into service, every vehicle shall be subject to technical inspection by the competent administration in the Member State. The dimension, weight and axle type specifications (with the nomenclature used in this Supplementary Act) shall be clearly inscribed in two plates:
 - a) A tare plate clearly displaying:
 - i) The unladen weight (UW) - at full tank;
 - ii) Authorized total laden weight (ATLW) of the vehicle; and
 - iii) Type of the vehicle axle.
 - b) A dimensions plate displaying the dimension specifications of the vehicle.
2. The two plates shall be affixed to the vehicle.
3. Technical inspection shall be compulsory upon a vehicle's entry into circulation after an accident or significant transformation thereto. The vehicle owner shall request for this inspection from the Competent Authority.
4. During the periodic vehicle inspection stipulated in Article 10 of Convention A/P2/5/82, the dimension and weight specifications inscribed on the plates shall be checked.
5. As regards an assembly of vehicles, the provisions of this Article shall apply to each component of the fleet.

Article 9 – Obligatory inspection of equipment and devices

A. For Member States

- 1) Pursuant Resolution C/RES.5/5/90 and for the purposes of effective inspection, Member States shall install or cause to be installed equipment for control of the set limits to vehicle load and dimensions. The equipment in question are essentially weighbridges, weighing scales and dimension gauges.
- 2) The said equipment shall be installed in the form of fixed posts along inter-State road corridors, at the beginning and at the end of such corridors, and at the borders where the equipment can be used

by the relevant authority of neighbouring Member States in line with the concept of adjoining check points. In addition, mobile weighing scales shall be used for unscheduled inspections.

- 3) It shall be the responsibility of the State to ensure that the inspection equipment is installed at the exit of urban agglomerations which generate annual road freight for heavy-duty vehicles of over two hundred thousand (200,000) ton
- 4) The equipment forming part of the installations referred to under paragraph 3 of this article shall be inspected frequently each year and recalibrated by a metrology service recognized or certified by the State.

B. For platforms that generate heavy traffic

- 1) Operators of port and airport transit platforms, logistics platforms, rail-road inter-modal platforms, warehousing and storage facilities, as well as industrial and/or mining institutions which generate heavy-duty vehicle goods traffic of over two hundred thousand (200,000) tones annually, shall equip their platforms or facilities with an installation having the specialized facilities required for inspection of the dimensions, weight and axle load of heavy-duty cargo transport vehicles loading in their respective domains.
- 2) The operator shall be required to obtain a certificate of compliance from the national administration in charge of transport
- 3) Member States shall ensure the implementation of these provisions by those in charge of platforms.

Chapter IV

Inspection of heavy-duty vehicles dimension, weight and axle load along road corridors

Article 10 – Responsibilities of loading platforms prior to departure of a laden truck

1. Operators of the platforms and facilities mentioned in Article 9(B) of the Supplementary Act shall ensure and certify in their inspection installations by their respective services or by any other service provider operating on behalf of their services, that the standards regarding the dimensions, weight and axle load limits for heavy-duty vehicles loaded in the said platforms and/or facilities have been complied with. The services or service providers in question shall accordingly issue an inspection certificate as provided for in Article 7 of this Supplementary Act.
2. Such inspection shall be conducted at the expense of the vehicle operator. The inspection certificate where so issued shall be kept aboard the vehicle for presentation on demand during road inspections.
3. The vehicle may not leave the premises of the platform or facility with its cargo and re-embark on the journey unless it is in compliance with the standards set forth by this Supplementary Act, or the vehicle operator has an authorization for exceptional transport. Prohibition from leaving the platform/facility premises for non-compliance shall be the responsibility of the owners of the said platforms or facilities.
4. Every urban agglomeration generating outgoing road cargo traffic for heavy-duty vehicles of over two hundred thousand (200,000) tones annually shall offer every heavy-duty vehicle transporter the opportunity to ensure that his/her laden vehicle conforms with the dimensions, weight and axle load standards set for such vehicles. The offer shall be extended by putting in place an appropriate technical facility operated by or on behalf of the services of the administration or by a private operator accredited by the road administration.

Article 11 – Responsibilities of vehicle operators prior to departure of laden trucks

The vehicle operator or his/her representative shall ensure that, at the point of loading and of departure that the said vehicle is compliant with the dimensions, weight and axle load standards set for the vehicle. The vehicle

operator shall be held responsible, unless proved otherwise, for non-compliance with the said standards on public roads.

Article 12 – Inspection at fixed posts

1. Each fixed inspection post shall, at the minimum, be equipped with vehicle weighing facility for inspection of axle load and total vehicle weight, as well as a facility for measuring vehicle dimensions. The fixed inspection posts shall have secured cargo warehousing facilities and secured parking spaces for immobilized vehicles in order to facilitate implementation of the sanctions set forth in Articles 16 and 17 of the Supplementary Act.
2. The number of inspection posts along any Community transit corridor in a Member State may not exceed three [3] in each traffic direction, including the posts in the precincts of the aforementioned sources of heavy traffic where such posts are located on the border corridors and posts. The inspection posts situated on Community transit corridor feeder roads are not subject to this limit.
3. Weighing-toll posts shall not be included in the number of inspection fixed posts mentioned in paragraph 2 of this Article. Transit transport vehicles with the stickers provided for in the regional road inspection plan shall not be subject to the weighing formalities at the said weighing-toll posts.

Article 13 – Inspection by mobile brigade

1. In addition to establishing the system of inspection fixed posts stipulated in Article 12, the road inspection system in each Member State shall be provided with standardized mobile equipments.
2. Mobile road inspection shall be conducted without prior notice. It is primarily intended to control offences and fraud committed on crossing inspection fixed posts. It is also aimed at controlling the vehicles not intercepted at an inspection fixed post. Mobile road inspection shall entail only the verification of compliance with the standards stipulated in this Supplementary Act.
3. Mobile road inspection along any Community transit corridor in a Member State may be operated only within the limits of a total of three consecutive inspection points, in each traffic direction along the corridor, fixed posts and mobile inspection posts inclusive, counted in the same way as in Article 12 above.
4. Inspection at mobile check points shall be conducted at random and through sampling of units of traffic plying the road without forming a queue. No other vehicle in circulation shall be intercepted during a vehicle inspection operation; and no vehicle shall be kept waiting for the purpose of inspection.
5. A transit transport vehicle may be inspected right through the journey, for every transit corridor in a Member State.

Article 14 – Content of road inspection and mode of management

1. Apart from the inspection of vehicle and driver's particulars, fixed and mobile posts inspection shall entail verification of conformity with the dimension and load standards set forth in Articles 3, 4 and 5 of this Supplementary Act.
2. In each Member State, the road inspection system defined in Articles 12 and 13 of this Supplementary Act and the mode of management and operation thereof fall under the purview of the Member State, with the exception of the adjoined inspection posts at the border of two Member States, which shall be governed by a special regime.
3. The inspection posts juxtaposed at the border of two Member States shall be located on common land entry-exit platforms. Legal provisions defining the status of such platforms shall be put in place by the ECOWAS Commission.

Chapter V

Sanctions for non-compliance with the dimensions, weight and axle load limits

Article 15 – Content of the sanctions

1. A breach of the standards and non-compliance with the responsibilities laid down in this Supplementary Act shall attract sanctions set forth in Articles 16 to 24 hereunder.
2. In general terms, in the event of non-conformity with dimensions and weight limits, the sanctions imposable shall comprise:
 - a) Corrective measures as well as measures imposed to oblige compliance with the relevant standards (weight and load shedding) at the expense of the offender with a view to eliminating the impact of the offence on the rest of the journey;
 - b) Dissuasive fine determined in accordance with seriousness of the offence to be defined in the manner provided under Article 18 of this Supplementary Act.
3. The level of fine for overloading shall be determined in such a way that the amount applicable shall be at least equal to the income expected by a public transporter on the transportation of the cargo weight that constituted the overload. In this regard, account shall be taken of the average cost of heavy-duty transportation of a kilometer tone and the average transportation distances in respect of national and inter-State transport.

Article 16 – Compulsory overload shedding and correction of dimensions

1. The operator of a vehicle found to be non-compliant with the loading standards stipulated in this Supplementary Act shall have the obligation to conform with the Act prior to putting the vehicle back in circulation.
2. Payment of the fine incurred notwithstanding, the vehicle operator shall be required to cause the excess load to be discharged and/or re-order the vehicle load with a view to bringing the vehicle load and dimensions back to permissible limits.
3. The operations to load and re-load off-loaded cargo shall be the responsibility of the vehicle operator who shall exclusively bear the cost.
4. In the case of a sealed vehicle or a transit transport vehicle under ISRT regime, the operations referred to in paragraph 3 of this Article shall be conducted under customs oversight.
5. Where a non-compliant vehicle is intercepted by mobile inspection, such vehicle shall be immediately escorted to the nearest inspection fixed post.

Article 17 – Immobilization of vehicle and compulsory cargo trans-shipment

1. Where an inspected vehicle is found to be in breach of the dimension standards set forth in Article 3 of this Supplementary Act and the cause of the non-compliance is not due to loading but solely to the technical specifications of the vehicle, the vehicle operator shall be required to transfer its cargo to another vehicle that is compliant with the dimension standards.
2. The defaulting vehicle shall be immobilized at the inspection post under the responsibility of the post operator pending the arrival of the inspection post vehicle to which the cargo is to be trans-shipped. The trans-shipment shall be Effected at the inspection post by the vehicle operator under the supervision of the post operator.

3. The owner of the non-compliant vehicle shall be sanctioned with immobilization of the said vehicle at a location indicated by him/her, until the vehicle is brought to conformity.

Article 18 – Fine

1. The amounts for fines attached to sanctions prescribed under chapter 5 of this Supplementary Act shall be defined in a Regulation to be adopted by the Council of Ministers on the recommendation of the sector Ministers. All such fines shall be calculated in the United States dollars but paid in the appropriate local currency. The amounts shall be reviewed periodically by the Council of Ministers on the advice of the sector Ministers.

2. **In the absence of dimension and tare plates**

Any owner of a vehicle without the dimension and tare plates stipulated in Article 8 of this Supplementary Act shall be sanctioned with a fine.

3. **For lack of inspection certificate**

1. Any international transport vehicle without inspection certificate in its set of travel documents as prescribed in Article 7 of this Supplementary Act, or without the authorization for exceptional transport in lieu of the certificate, shall be sanctioned with a fine in exchange for the eventual issuance of a certificate of compliance in lieu of inspection certificate, to complete the rest of the journey.
2. In the event of a mobile inspection, the defaulting vehicle shall be escorted to the nearest stationed inspection post for the purpose of issuance of the requisite certificate after verification of compliance with all the prescribed limits.

4. **For breach of dimension standards**

1. Any breach of the dimension standards resulting exclusively from vehicle load shall attract a fine at the expense of the operator of the vehicle.
2. Any breach of the dimension standards due exclusively to the specifications of the vehicle shall be punished with a fine at the expense of the owner of the vehicle and immobilization shall be imposed in accordance with the provisions of Article 17 of the Supplementary Act.

5. **For exceeding the total travelling weight of the vehicle**

Any overload beyond the regulated total laden weight of a vehicle or assembly of vehicles with regard to national and inter-state transport shall attract fines to be determined in the manner provided for under Article 18(1) of this Supplementary Act. A five percent (5%) allowance on the total laden weight is however made to take into account the margin of error of the weighing facility.

6. **For axle overload**

1. Any excess of axle load for national and international transport in violation of the standards set forth in Article 4 of this Supplementary Act shall attract fines calculated per ton overload in respect of the axle accounting for the highest overload amongst all the axles of the vehicle.
2. Where the two kinds of overload, namely, weight overload and axle overload, have been observed in respect of the same road transport vehicle, the penalty applicable shall be the highest.

Article 19 – Special case of transportation of hydrocarbons, explosives and certain dangerous cargo

1. In special cases where the cargo transported by the weight or dimension non-compliant vehicle is composed of hydrocarbons, explosives and certain dangerous cargo which cannot be manipulated and/or stored in inspection fixed post facility for security reasons, the vehicle shall immediately be escorted to its

loading point, its journey starting point, the off load point or destination, depending on the point with the shortest distance between the two destinations, that is, from the inspection point where the offence was observed, and the fixed or mobile post.

2. The fine applicable shall be double the fine set for similar offence in case of ordinary cargo transport.
3. With respect to transit transport, escorting the vehicle back to the loading point shall be supervised by the customs.

Article 20 – Increased fine for repeated breach

1. Repeated breaches of the standards in respect of both dimension and load shall attract increased fines at rates determined in a Council Regulation as stated in Article 18(1) of this Supplementary Act.
2. For the purpose of implementing the provisions of sub-paragraph 1 of this Article, annual computation of offences shall be carried out in respect of the offences committed in the territory of the same State and detected at the control system. Such computation shall be managed by the operator of the inspection system.
3. In the special case of adjoining inspection posts at the borders, the provisions of Paragraph 1 of this Article above shall be applied on the basis of computation of offences detected at the same joint border post.

Article 21 – Fines for proven offences at inspection fixed posts

During unscheduled mobile inspection, any offence or offences involving a vehicle at the last inspection of dimension, weight and axle load at a fixed post shall attract the requisite fine. This sanction shall be additional to the other sanctions defined in earlier Articles.

Article 22 – Obligation to implement sanctions

A defaulting vehicle may not be authorized to leave the inspection fixed post or the destination designated for the vehicles mentioned in Articles 17 and 19 of this Supplementary Act, unless the vehicle operator produces proof that the requirements laid down under the sanctions have been met, and that the fine and other sanctions imposed have been cleared at the inspection fixed posts holding and processing the dossier regarding the offense.

Article 23 – Fine imposed for deliberate refusal to pass through the weigh-bridge and axle weighing scales

Any deliberate refusal by the driver of a vehicle to pass through the weigh bridge or axle weighing scale shall be sanctioned in addition to such other coercive measures as may be applicable. Such sanction shall be imposed on the vehicle operator who may institute a claim against the driver.

Article 24 – Sanction against platforms and facilities generating out-going road traffic of over 200,000 tones

1. Any corporate body operating a platform or facility of the category defined in Article 9 (B) of this Supplementary Act without the compulsory inspection facilities mentioned in the said Article, shall attract a fine. This fine becomes applicable at the expiration of two years deadline following the formal notification of the obligation to be compliant, issued by the national administration in charge of transport where the corporate body in question fails to meet the obligation.
2. Any corporate body referred to under Article 9 (B) that has conformed with the obligations in terms of the inspection equipment and facilities mentioned in the same Article but is in breach of the obligations regarding vehicle inspection and prohibition from leaving the inspection post defined in Article 10 of

this Supplementary Act, shall be sanctioned with a fine per any vehicle loaded in the precincts of the defaulting platform or facility.

Chapter VI General and final provisions

Article 25 – Adaption and/or amendment of technical standards of vehicles and sanctions

1. The technical standards for heavy duty goods transporting vehicles plying public highways within the limits of dimension of heavy vehicles, axle load, laden load shall be adapted periodically in line with improvements in the manufacturing technology of vehicles.
2. Consequently annexes 1, and 2 attached to this Supplementary Act, and which are part thereof shall be adapted or modified by a Decision of the Council of Ministers upon the recommendation of the sector Ministers.

Article 26 – Other obligations

1. A Member State shall not have the right to refuse or prohibit the use of vehicles registered or put into service in any other Member States on its territory for reasons pertaining to the dimensions and weight if such vehicles comply with the maximum values specified in annex 1 and 2 of this Supplementary Act.
2. The provision of paragraph 1 of this Article shall be applicable notwithstanding the fact that the said vehicles do not comply with the provisions of the laws of the Member State regulating some weight and dimension specifications that are not covered by this Supplementary Act.
3. No Member State shall authorize the normal circulation of vehicles or an assembly of vehicles on its territory if they do not comply with the specifications stated in this Supplementary Act.

Article 27 – Transition period

1. During a one-year transition period starting from the date of entry into force stated in article 29 below, Member States shall put in place their road control system as specified below:
 - i. By the end of the first six months of the transition period, weighing equipment shall be acquired and made operational and temporary areas shall be developed as fixed control posts for the storage of goods offloaded from overloaded vehicles;
 - ii. By the end of the transition period, road control systems shall be set and made operational as defined in this Supplementary Act.
2. By the end of a two year period starting from the date of entry into force stated in Article 29 below, vehicles transporting hydrocarbons in circulation in the region and which do not comply with the standards Set forth in this Supplementary Act shall be modified to make them compliant.
3. A road map defining the modalities for the implementation of this Supplementary Act shall be established by the Council of Ministers on the recommendation of the transport Sectoral Ministers.

Article 28 – Moratorium

1. In each Member State, a moratorium shall be applicable starting from the date of entry into force of this Supplementary Act as specified in paragraph (2) et (2) below.

2. A general moratorium limited to enforcement of fines shall be granted for a period of twelve (12) months during which only sanctions provided for under article 15 of the Supplementary Act shall be applied
3. Infringements shall be subject to a specific moratorium as follows:
 - Infringements which attract the sanction provided under paragraph C of Article 18 (4) of this Act: None for new vehicles or registered vehicles for the first time; (ii) one (1) year for other vehicles with the exception of Hydrocarbon transport Vehicle for which a period of two years has been granted;
 - Breach of provisions of Article 8 of this Supplementary Act: (i) none for new vehicles or vehicles registered for the first time; (ii) one (1) year for other vehicles with the exception of Hydrocarbon Transport Vehicles for which 2 years has been granted.

Article 29 – Publication

This Supplementary Act shall be published by the ECOWAS Commission in the Official Journal of the Community within thirty (30) days of its signing by the Heads of State and Government. It shall also be published by each Member State in its National *Gazette* within thirty (30) days of notification by the Commission.

Article 30 – Entry into force

This Supplementary Act shall enter into force upon its publication. Consequently, Member States shall undertake to commence implementation of its provisions upon its entry into force.

Article 31 – Miscellaneous provisions

The Supplementary Act shall supersede any other contrary provisions.

Article 32 – Depository authority

This Supplementary Act shall be deposited at the Commission which shall forward certified copies to all Member States and shall register same with the African Union, United Nations Organisation and all other organisations selected by the Council.

IN FAITH WHEREOF, WE, the Heads of State and Government of the Member States of the Economic Community of West African States (ECOWAS), have signed this Supplementary Act





Done at Abuja, this 19th day of July, 2011

In single original in English, French and Portuguese languages, all texts being equally authentic.



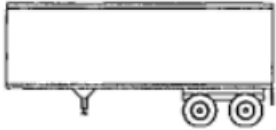
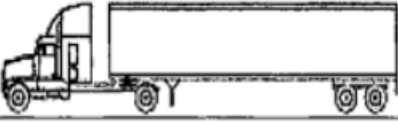

Annex 1

Definitions relating to the dimensions, weight and load of heavy-duty goods transport vehicles

Definitions relating to vehicle types

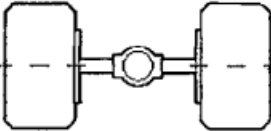
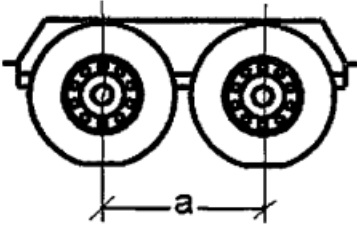
TERMS AND DEFINITIONS	BODY FRAME
<p>Heavy-duty /cargo vehicle</p> <p>Vehicle (or assembly of vehicles coupled to form a unit of traffic) whose authorized total travelling weight is above 3.5 tones</p>	
<p>Tractive unit</p> <p>A vehicle motorized so as to be self-propelling</p>	
<p>Cargo vehicle</p> <p>A motorized vehicle with a fixed cargo casing or platform, which bears its entire load on its frame.</p>	
<p>Road tractor</p> <p>A motorized (non-cargo) vehicle fitted with a "fifth wheel" as well as electrical and compressed air connections for semi-trailer lights and brakes.</p>	
<p>Truck trailer</p> <p>Non-motorized vehicle designed to be towed by a motorized vehicle. Truck trailer may also describe the last vehicle of a road train</p>	
<p>Semi-trailer</p> <p>Trailer without front axle, the wheelless part of which is designed to be coupled to a motorized towing vehicle such that part of this trailer rests on the motorized vehicle and that a substantial part of its weight and load weight rests on the said vehicle</p>	
<p>Articulated Vehicle</p> <p>Combination of vehicles consisting of a road tractor coupled to a semi-trailer</p>	
<p>Road train</p> <p>Vehicle combination consisting of a cargo vehicle</p>	
<p>and a trailer or a semi trailer</p>	
<p>Double road train</p> <p>Vehicle combination consisting of a tractor and two semi-trailers.</p>	

Definitions relating to axle types

TERMS AND DEFINITIONS		BODY FRAME
<p>Load carrying axle</p> <p>A set of wheels mounted symmetrically on the same axle beam to support a portion of the load.</p>		
<p>Axle spread/spacing</p> <p>Distance between the centers of the axle beams connected to the same suspension</p>		 <p>a : axle spread</p>
<p>Front axle</p> <p>Steering axle located at the front end of a motor vehicle</p>		
<p>Steering axle</p> <p>Load carrying axle with wheels mounted on the pivoting components</p>		
<p>Powered axle</p> <p>Load carrying axle which receives driving force from the transmission and transmits to the wheels</p>		 <p>Axle de transmission Essieu moteur</p>
<p>Single axle</p> <p>Axle system having only one load carrying axle</p>		

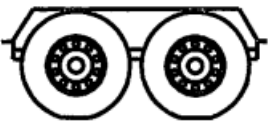
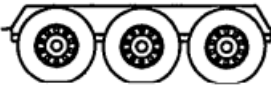
Tandem axle / Double axle Axle system composed of two axles, either of which may be powered or non-powered	Type 1 $a \leq 1m$	
	Type 2 $1m \leq a \leq 1,3m$	
	Type 3 $1,3m \leq a \leq 1,8m$	
	Type 4 $a \geq 1,8m$	
	Type 5 $a \geq 23t$	
Triple axle or tri-axle Running gear consisting of an assembly of three evenly spread load-carrying axles mounted on the same suspension	Type 1 $a \leq 1,3m$	
	Type 2 $1,3m \leq a \leq 1,4m$	
	Type 3 27t a	
	Type 3 27t a	
Twin or dual wheels	Dual wheels on each side of an axle	

Definitions relating to dimensions	
Overall external dimensions	Dimensions (length width and height) inclusive of all protrusions, load and accessories
Dimensions	Overall dimension or size (length, width and height) of an assembly of vehicles cargo unit inclusive
Maximum authorized dimensions	Permissible maximum dimension for a vehicle in circulation
Definitions relating to vehicle weight	
Axle load (AL)	Portion of vehicle weight borne by the axle
Authorized maximum axle load (AMAL)	The maximum axle load statutorily permissible for a vehicle in circulation on public road
Authorized total laden weight (ATLW)	The maximum total weight statutorily permissible for a laden vehicle in circulation
Authorized total operational weight (ATOW)	The maximum total weight statutorily permissible for an assembly of laden vehicles in circulation
Other definitions	
Vehicle driver	The person driving the vehicle at the time under control. This person could be the owner himself or an employee of the owner or any other person offering his services to the owner for a fee or free of charge
Vehicle operator/ transporter	A corporate body or an individual who uses a vehicle to transport goods on his own account or for another person. The vehicle belongs to the operator or hired by operator. In any other case, the operator is the same as the owner of the vehicle; it is the special case where the vehicle is borrowed.
Shipper or Consignor	Individual or corporate body owner or representative of cargo unit owner for whom the cargo is being transported
Traffic generating platform	
Way bill	A written record of the contract between the transporter and the shipper as provided in the OH ADA Uniform Act (stated above) regulating road transport of goods. The shipper shall also be defined as the consignee.

Moratorium	Period starting from the entry into force of this Regulation during which none of the monetary sanctions shall be applied.
Road control system operator or operator	A public or private corporate body managing and operating a road control system to check the dimensions, weight and axle load of vehicles
Common land exit/entry platform	A border platform hosting the joint border control post and considered as a common land entry and exit point of two sharing a common border
Joint border control post	A place developed and equipped, near the border in one of two neighboring countries, housing the post used by both border control services at the borders of the two neighboring countries to conduct border control operations at the exit point of one country and entry point for the others.
ISRT	Inter-State Road Transit



Annex 2

Dimension, weight and axle load standards for heavy-duty cargo transport vehicles

Dimension limit for heavy duty cargo transport vehicles		
Dimensions	Vehicle	Maximum autorised
Length inclusive of all protrusions, load and accessories	Cargo carrier - Single engine vehicle	12 m
	Semi-trailer between the kingpin and the back)	12 m
	Trailer (without coupling mechanism)	12 m
	Articulated Vehicle	18.75 m
	Road train Coupled assembly of vehicles (cargo carrier + trailer)	18.75 m
	Double train for car transportation	18.00 m
	Double train for container transportation	24.20 m
	Other road train/double train	22 m
Width inclusive of all protrusions, load and accessories	Transport vehicle with controlled temperature	2.65 m
	Other vehicles	2.55 m
	Trailer with «twist lock »	2.70 m
Height inclusive of all protrusions, load and accessories	Any vehicles	4.50 m
Authorized maximum axle load (AMAL)		

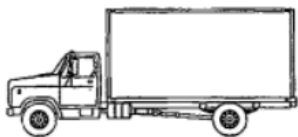
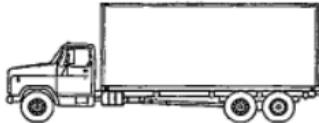

Axle type		AMAL
Single front axle		9t
Single intermediary or rear axle	Single wheel	11.5t
	Twin wheels	12t
Dual (tandem) intermediary or rear axle 24	Type 1	11.5t
	Type 2	16t
	Type 3	18t
	Type 4	20t/23t
Triple axle (tri-axle)	Type 1	21t
	Type 2	25t
	Type 3	27t
	Type 4	31.5t

Authorized total weight of some common vehicles

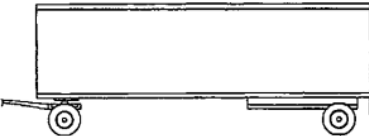
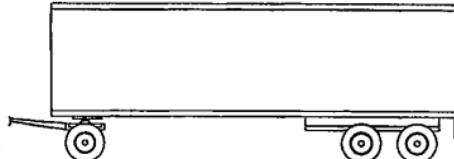
VEHICLE	ATLW	VEHICLE	ATLW
1 Vehicle with 2 axles (9 ; 12) P11 	18 tonnes	2 Vehicle with 3 axles, one of which is type tandem type4 (9 ;23t) P12 	26 tonnes
3 Vehicle with 4 axles, one of which is tridem type 2 (9 ;27t), P13 	31 tonnes	3b Vehicle with 4 axles, one of which is tandem type 2 (9 ; 12; 23) P112 	31 tonnes



4	Trailer with 2 axle (9 ; 12t) R11 	18 tonnes	5	Trailer with three axles, one of which is a tandem (9 ;23t) R12 	26 tonnes
---	-------------------------------------------------------------------------------------------------------------------------------	-----------	---	--------------------------------------------------------------------------------------------------------------------------------------------------------------	-----------

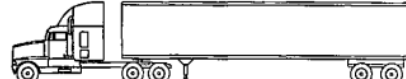

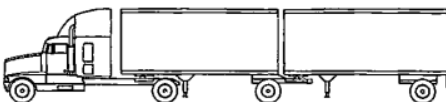

	Vehicle	PTRA		Vehicle	PTRA
--	---------	------	--	---------	------

6	Articulated vehicle with 3 axles (9 ; 12 ; 12t) T11S1 	30 tonnes	7	Articulated vehicle with 4 axles, one of which is tandem type 4 (9 ; 12 ; 23t) T11S2 or (9 ; 23 ; 12), T12S1 	38 tonnes
8	Articulated vehicle with 5 axles, one of which is tridem type 2. (9 ; 12 ; 27t), T11S3 	43 tonnes	9	Articulated vehicle with 5 axles, two of which are tandem type 4 (9 ;23 ;23t) T12S2 	46 tonnes

10	Articulated Vehicle with 6 axles, with 1 tandem type 4 and 1 tridem type 2 (9 ;23 ;27) T12S3 Six axle or more vehicle 	51 tonnes			
----	------------------------------------------------------------------------------------------------------------------------------------------------------------------------------------------------------------------------	-----------	--	--	--

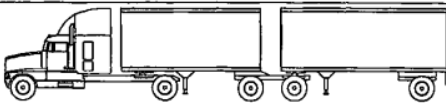

	Vehicle	PTRA		Vehicle	PTRA
--	---------	------	--	---------	------

11	Road Train (cargo vehicle – trailer with four simple axle (9 ;12 ;12 ;12) P11R11 	38tonnes	11b	Dual train with 4 simple axle (9 ; 12 ; 12 ; 12) T11S1S1 	38tonnes
12	Road Train (cargo vehicle + trailer) with 5 axle (9; 20; 12; 12) P12R11 or (9; 12; 12; 20) P11R12 	44tonnes	12b	Double Train with 5 axle (9;12;23;12) T11S2S1 or (9;23;12; 12) T12S1S1 	44tonnes

				
12c	Road Train (cargo vehicle – trailer) with 6 axle (9 ; 23 ; 9 ; 23) P12R12 	44tonnes	12d Double train with 6 axle (9 ; 23 ; 23 ; 12) T12S2S1 	44tonnes
13	Six axle Road Train (cargo vehicle + trailer) (9 ; 27 ; 23) P13S2 	51tonnes		

	Vehicle	PTRA		Vehicle	PTRA
--	---------	------	--	---------	------

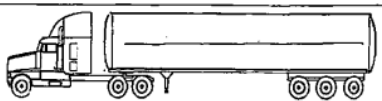
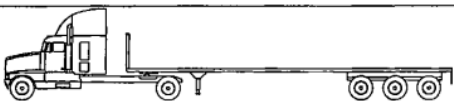
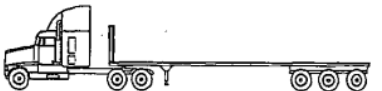
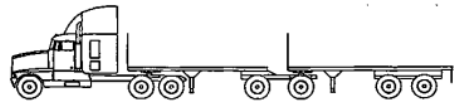
14	Articulated vehicle with 6 axle for HYDROCARBON TRANSPORT (9 ; 23 ; 31,5) T12S3	59tonnes *	15	Articulated vehicle with 5 axle for CONTAINER COMBINED TRANSPORT (9 ; 12 ; 31,5) T11S3	46tonnes
----	----------------------------------------------------------------------------------------	------------	----	-----------------------------------------------------------------------------------------------	----------

					
16	Articulated vehicle with 6 axle for CONTAINER COMBINED TRANSPORT (9 ; 23 ; 31,5) T12S3 	56tonnes	17	Articulated vehicle with 7 axle for CONTAINER COMBINED TRANSPORT (9 ; 23 ; 23 ; 23) T12S2S2 	64tonnes
18	Articulated vehicle with 8 axle for CONTAINER COMBINED TRANSPORT (9 ; 23 ; 31,5 ; 23) T12S3S2 	75tonnes	19	Articulated vehicle with 9 axle for CONTAINER COMBINED TRANSPORT (9 ; 23 ; 31,5 ; 31,5) T12S3S3 	80 tonnes